



INFINIEBAR

Product Manual

English

Introduction

Thank you for purchasing the Aputure® INFINIBAR.

The Aputure INFINIBAR is a full spectrum LED tube light for cinematographers and lighting professionals. Featuring total color and pixel control in a compact form factor, the INFINIBAR is your new filmmaking paintbrush.

Granting you true creative freedom, the INFINIBAR utilizes advanced wireless connectivity with our innovative Sidus Link mobile app and the industry-standard Lumenradio CRMX for wireless DMX adjustability.

Important Safety Instructions

When using this unit, basic safety precautions should always be followed, including the following:

1. Read and understand all instructions before using.
2. Please keep INFINIBAR away from diskette, credit cards, monitors, mechanical watches, mobile phones, medical devices (pacemakers), etc.
3. Close supervision is necessary when any fixture is used by or near children. Do not leave the fixture unattended while in use.
4. Care must be taken as burns can occur from touching hot surfaces.
5. Do not operate the fixture if a cord is damaged, or if the fixture has been dropped or damaged, until it has been examined by qualified service personnel.
6. Position any power cables such that they will not be tripped over, pulled, or put into contact with hot surfaces.
7. If an extension cord is necessary, a cord with an amperage rating at least equal to that of the fixture should be used. Cords rated for less amperage than the fixture may overheat.
8. Always unplug the lighting fixture from the electrical outlet before cleaning and servicing, or when not in use. Never yank the cord to remove the plug from the outlet.
9. Let the lighting fixture cool completely before storing. Unplug the power cable from lighting fixture before storing and store the cable at assigned space of the flight case.
10. To reduce the risk of electric shock, do not immerse this fixture in water or any other liquids.
11. To reduce the risk of fire or electric shock, do not disassemble this fixture. Contact cs@aputure.com or take the lighting fixture to qualified service personnel when service or repair is required. Incorrect reassembly may cause electric shock when the lighting fixture is in use.
12. The use of any accessory attachment not recommended by the manufacturer may increase the risk of fire, electric shock, or injury to any persons operating the fixture.
13. Please power this fixture by connecting it to a grounded outlet.
14. Please do not block the ventilation or do not look at the LED light source directly when it is powered on. Please do not touch the LED light source in any condition.
15. Please do not place the LED lighting fixture near any flammable object.
16. Only use a dry microfiber cloth to clean the product.
17. Please do not use the light fixture in wet condition on account of electric shock may be caused.
18. Please have the product checked by an authorized service personnel agent if the product has a problem. Any malfunctions caused by unauthorized disassembly are not covered by the warranty. The user may pay for maintenance.
19. We recommend only using the original Aputure cable accessories. Please note that any malfunctions caused by using unauthorized accessories are not covered by the warranty. The user may pay for maintenance.
20. When hanging the product overhead, always ensure an extra safety measure has been attached - such as

a safety chain- that is certified for the weight of the product.

- 21. This product is certified by RoHS, CE, KC, PSE, and FCC. Please operate the product in full compliance with relevant country's standards. Any malfunctions caused by incorrect use are not covered by warranty. The user may pay for maintenance.
- 22. The instructions and information in this manual are based on thorough, controlled company testing procedures. Further notice will not be given if the design or specifications change.

SAVE THESE INSTRUCTIONS

FCC Compliance Statement

WARNING

Changes or modifications not expressly approved by the party responsible for compliance could void the user's authority to operate the equipment.

NOTICE

This equipment has been tested and found to comply with the limits for a Class B digital device, pursuant to Part 15 of the FCC Rules. These limits are designed to provide reasonable protection against harmful interference in a residential installation. This equipment generates, uses, and can radiate radio frequency energy and, if not installed and used in accordance with the instructions, may cause harmful interference to radio communications. However, there is no guarantee that interference will not occur in a particular installation.

If this equipment does cause harmful interference to radio or television reception, which can be determined by turning the equipment off and on, the user is encouraged to try reorient or relocate the receiving antenna.

- Increase the separation between the equipment and receiver.
- Connect the equipment to an outlet on a different circuit than the receiver is connected to.
- Consult the dealer or an experienced radio/TV technician for help

RF Warning Statement:

This device has been evaluated to meet general RF exposure requirements.

Components List

Please make sure all accessories listed below are completed before using. If not, please contact with your sellers immediately.

INFINIBAR PB12 8-Light Kit



Magnet (16pc)



Hex Key (1pc)

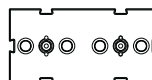

Straight Connector (8pc)

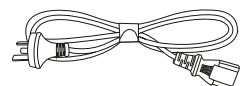

AC power cable 4m (1pc)

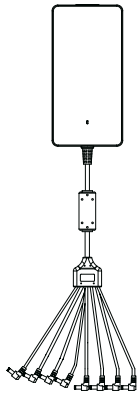

330W Power adapter (1pc)

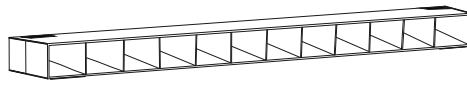

INFINIBAR PB12 fabric grid (8pc)

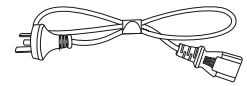

AC Power Cable 1.5m (8pc)

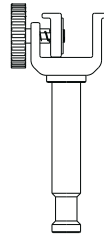

INFINIBAR Clamp (8pc)

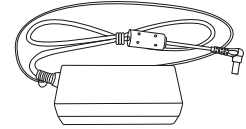

48W Power Adapter (8pc)

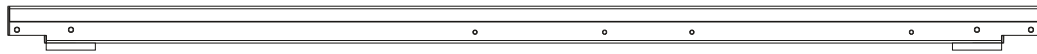

INFINIBAR PB12 lamp (8pc)

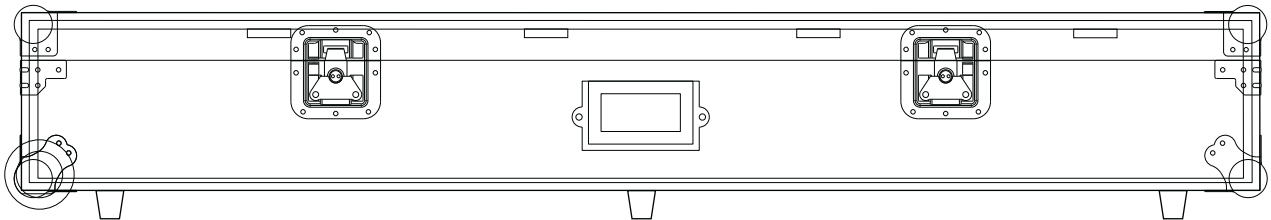

Flight case (1pc)

INFINIBAR PB6 8-Light Kit



Magnet (16pc)



Hex Key (1pc)

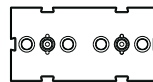

Straight Connector (8pc)

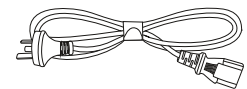

AC power cable 4m (1pc)

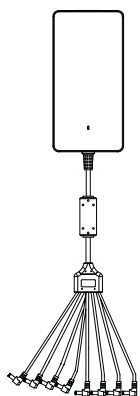

330W Power adapter (1pc)

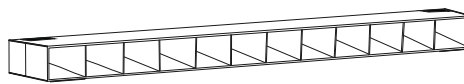

INFINIBAR PB6 fabric grid (8pc)

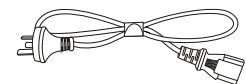

AC Power Cable 1.5m (8pc)

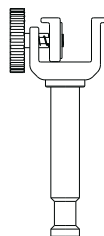

INFINIBAR Clamp (8pc)

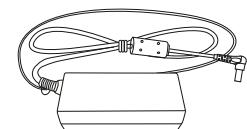

48W Power Adapter (8pc)

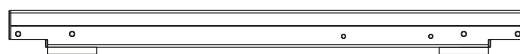

INFINIBAR PB6 (8pc)

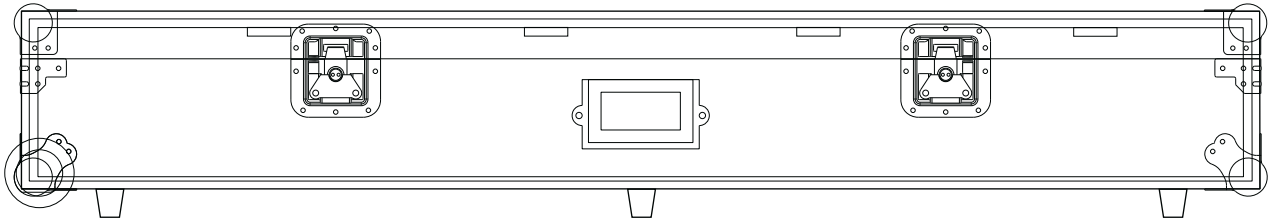

Flight case (1pc)

INFINIBAR PB3 16-Light Kit



Hex Key (1pc)

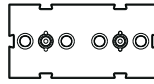

Straight Connector (16pc)

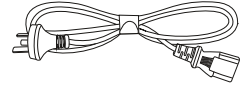

AC power cable 4m (1pc)

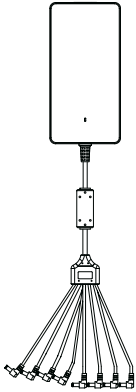

330W Power adapter (1pc)

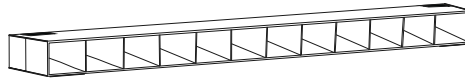

INFINIBAR PB3 fabric grid (16pc)

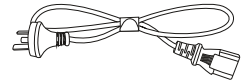

AC Power Cable 1.5m (8pc)

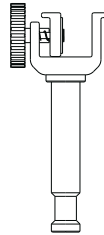

INFINIBAR Clamp (16pc)

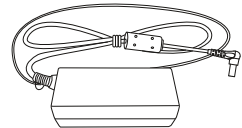

48W Power Adapter (8pc)



4-Way Power Splitter Cable (8pc)

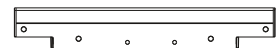

INFINIBAR PB3 (16pc)

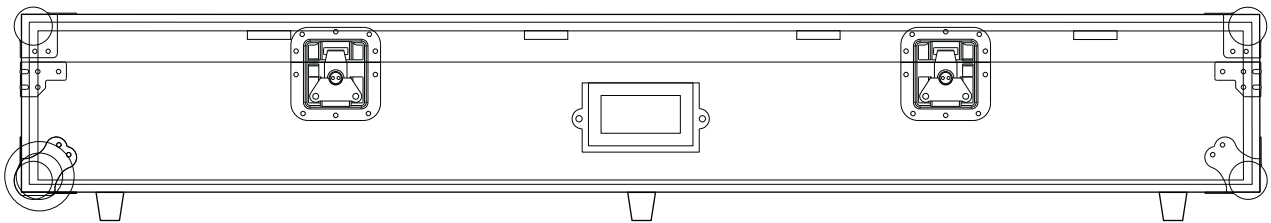

Flight case (1pc)

Tips: The illustrations in the manual are only diagrams for reference. Due to the continuous development of new versions of the product, if there are any differences between the product and the user manual diagrams, please refer to the product itself.

Product Details

1. Single lamp view

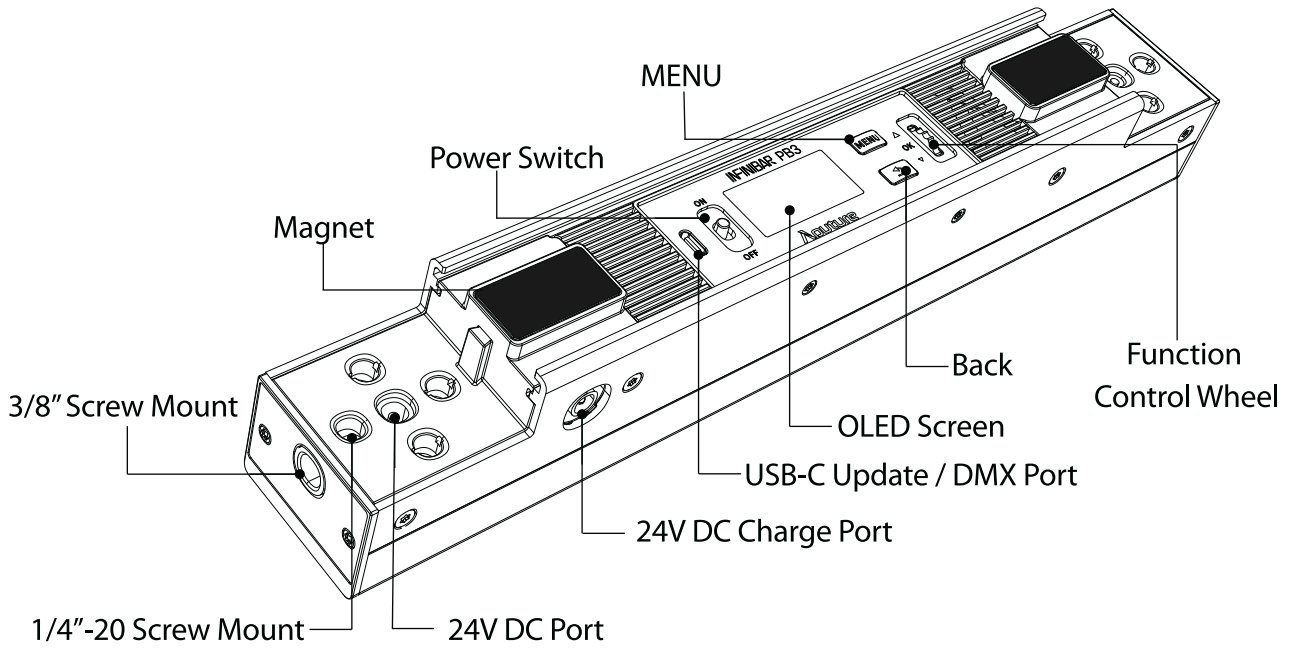

2. Multi-Light View

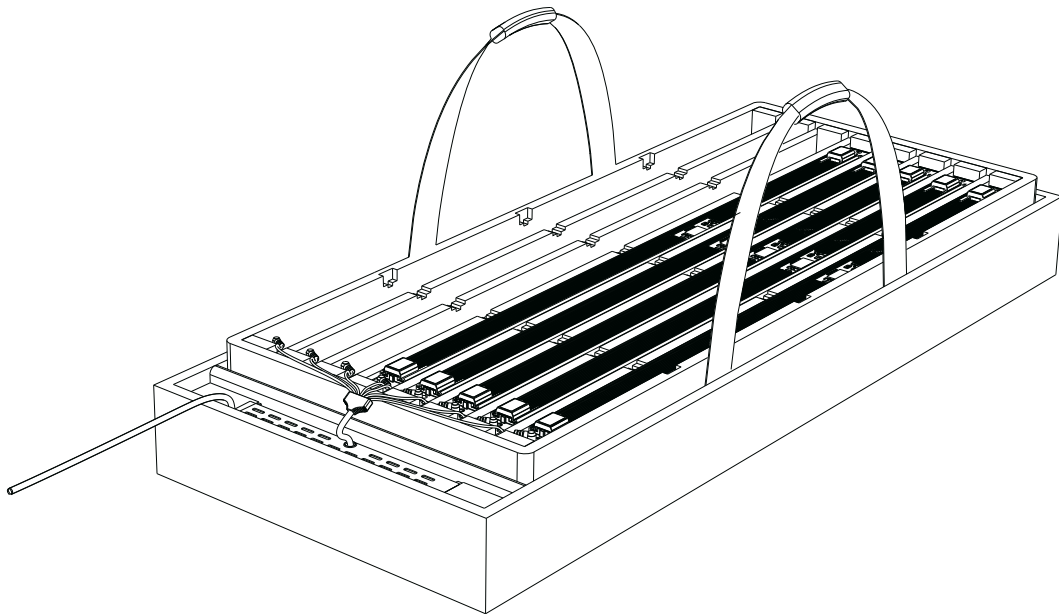

Installations

1. Magnets

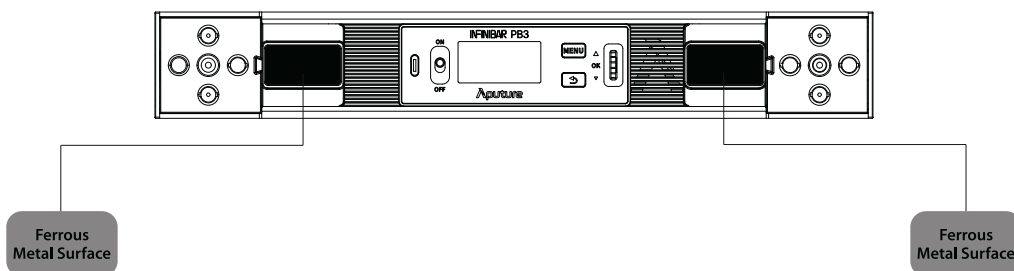

2. Connectors

Align the connector with the 1/4" thread holes and DC charge port on the back of the fixture and press it down, tighten screws with the hex key.

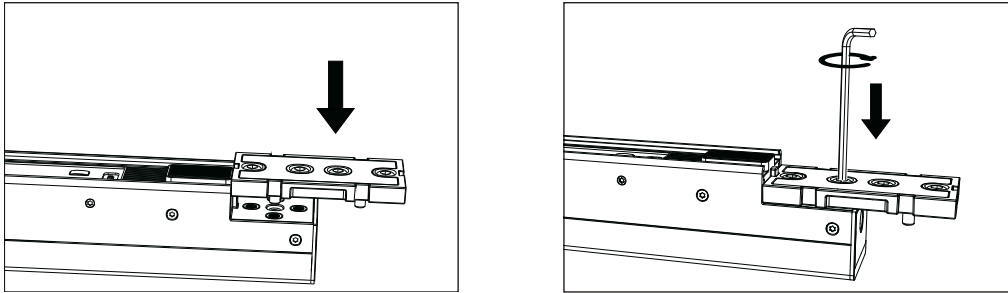

3. Connectors limit

Connect of the same style

| | Non-closed loop connections | Closed loop connections |
|------|-----------------------------|-------------------------|
| PB3 | 14 pcs | 24 pcs |
| PB6 | 8 pcs | 12 pcs |
| PB12 | 4pcs | 6pcs |

Connect of the different style

| | Maximum power |
|-------------------------|---------------|
| With PB3 | 144 W |
| With PB6 or PB12 | 168W |
| Closed loop connections | 240 W |

**When using the closed-loop connections, please ensure that infinibars are completely closed-loop, otherwise the connectors will be burned and the risk of short circuit will occur.*

Operations

1. Power ON/OFF

Adjust the position of the power switch to turn the light on or off.

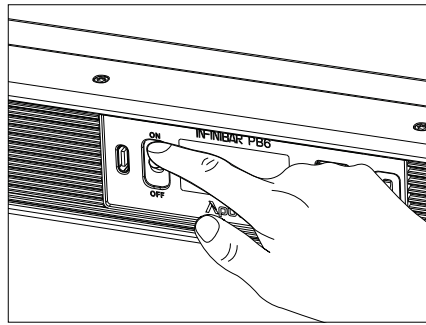

2. Powering up the Light

Use the power adapter to charge the lamp

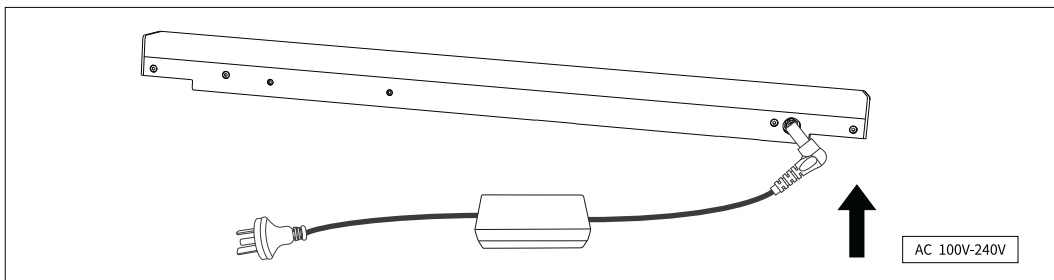

Use the flight case to charge the lamps

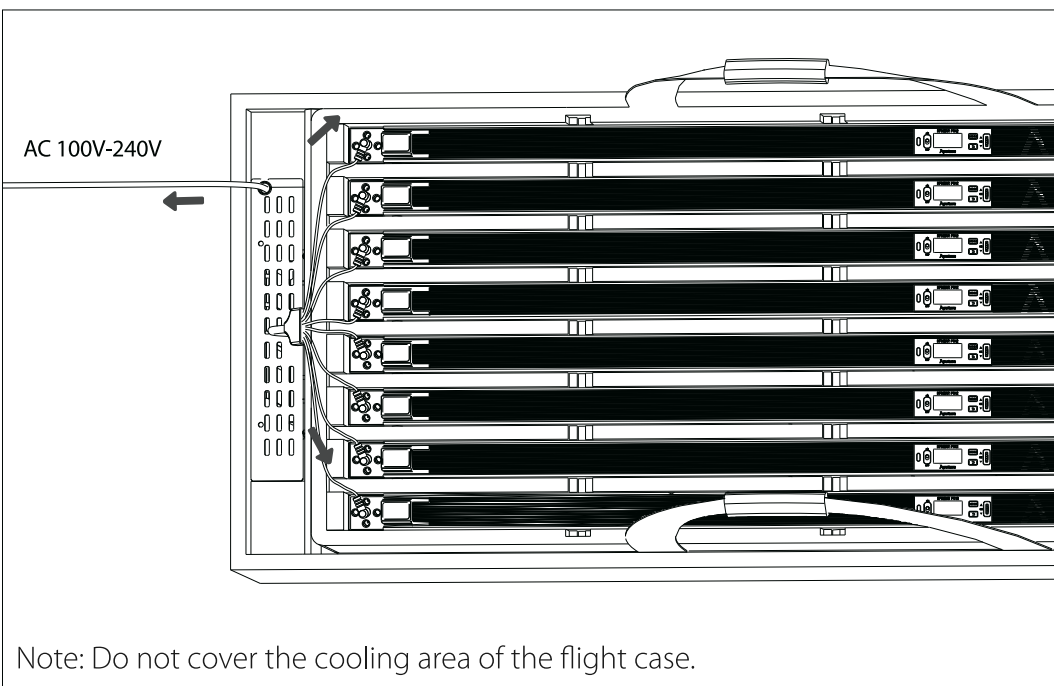
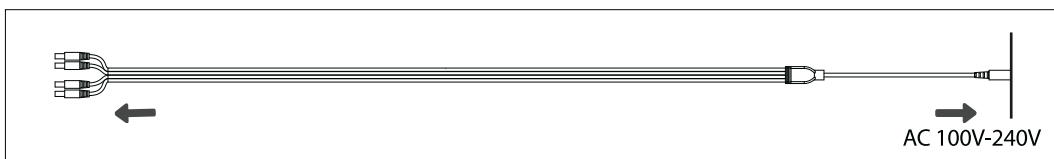

Note: Do not cover the cooling area of the flight case.

** Charging rate will slow down when the light is powered on. Turn the light off for optimal charging.*

3. Manual Control

3.1 UI Introducing

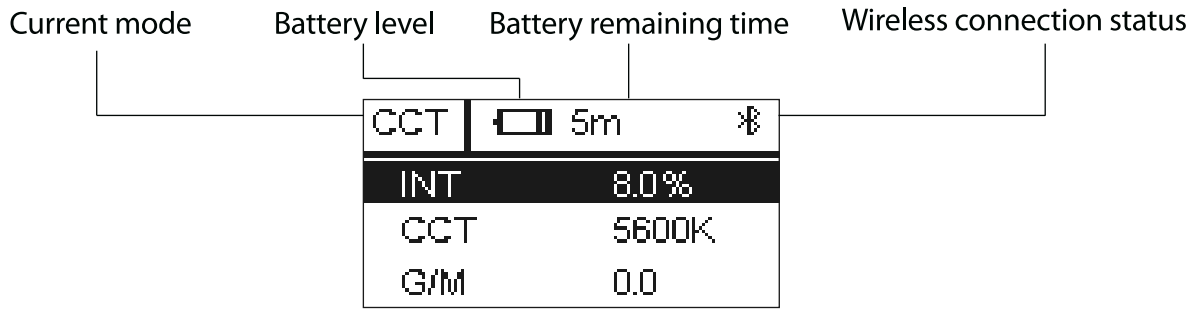

3.2 Menu

Press MENU to access the system menu, rotate and press the control wheel to select **CCT / HSI / RGB / FX / Custom FX / Overheat Prot. / Runtime / Freq. Selection / DMX Setting / CRMX Setting / BT Setting / Studio Mode / Update / Language / Factory Reset / Product Info / Screensaver / Exit.**

3.3 CCT

Press MENU to access the system menu, rotate and press the control wheel to select CCT mode.

| | | |
|-----|-------|---|
| CCT | 5m | ⌘ |
| INT | 8.0% | |
| CCT | 5600K | |
| G/M | 0.0 | |

INT (Intensity): 0 - 100 %;
CCT (Corelated color temperature): 2000 K - 10000 K;
G/M (Green / Magenta): -1.0 - +1.0;

3.4 HSI

Press MENU to access the system menu, rotate and press the control wheel to select CCT mode.

| | | |
|-----|-------|---|
| HSI | 5m | ⌘ |
| INT | 50.0% | |
| HUE | 360 ° | |
| SAT | 100 % | |

INT (Intensity): 0 - 100 %;
HUE (Hue) : 0.1 - 360°;
SAT (Saturation): 0 - 100 %;
CCT (Corelated color temperature): 2000 K - 10000 K.

3.5 RGB

Press MENU to access the system menu, rotate and press the control wheel to select RGB mode.

| | | |
|-----|-------|---|
| RGB | 5m | ⌘ |
| INT | 50.0% | |
| R | 50.0% | |
| G | 50.0% | |

INT (Intensity): 0 - 100 %;
R (Red): 0 - 100 % ;
G (Green): 0 - 100 % ;
B (Blue): 0 - 100 % ;

3.6 FX

Press MENU to access the system menu, rotate and press the control wheel to select FX mode.

3.6.1 System FX

press the control wheel to select system FX, rotate and press the control wheel to select **Paparazzi II** / **Lightning III** / **TV III** / **Fire III** / **Faulty Bulb III** / **Pulsing III** / **Cop car III** / **Party Lights II** / **Fireworks II**.

Each FX has multiple parameters that can be changed to customize the effects.

| Paparazzi II | |
|--------------|-------|
| INT: | 50.0% |
| CCT: | 5600K |
| G/M: | 0.0 ▼ |

| Lightning III | |
|---------------|---------|
| INT: | 50.0% |
| Mode: | CCT |
| CCT: | 7500K ▼ |

| TV III | |
|-----------|-------|
| INT: | 30.0% |
| Mode: | CCT |
| CCT Rang: | ▼ |

| Fire III | |
|-----------|-------|
| INT: | 48.0% |
| Mode: | CCT |
| CCT Rang: | ▼ |

| Faulty Bulb III | |
|-----------------|---------|
| INT: | 50.0% |
| Mode: | CCT |
| CCT: | 5600K ▼ |

| Pulsing III | |
|-------------|---------|
| INT: | 50.0% |
| Mode: | CCT |
| CCT: | 5600K ▼ |

| Cop Car III | |
|-------------|---------|
| INT: | 50.0% |
| Color: | R+B |
| FRQ: | Quint ▼ |

| Party Light II | |
|----------------|-------|
| INT: | 50.0% |
| SAT: | 100% |
| Speed: | 2S ▼ |

| Fireworks II | |
|--------------|-------|
| INT: | 50.0% |
| Mode: | HUE |
| Intervals: | ▼ |

3.6.2 Pixel FX

Press the control wheel to select system FX, rotate and press the control wheel to select **Color Fade** / **Color Cycle** / **One Pixel Chase** / **Two Pixel Chase** / **Three Pixel Chase** / **Rainbow** / **Pixel Fire**.

Each FX has multiple parameters that can be changed to customize the effects.

| Color Fade | |
|------------|------------------------------------|
| Color INT: | <input type="text" value="50.0%"/> |
| Color No: | 4 |
| Color 1: | CCT5600K ▼ |

| Color Cycle | |
|-------------|------------------------------------|
| Color INT: | <input type="text" value="50.0%"/> |
| Color No: | 4 |
| Color 1: | CCT5600K ▼ |

| One Color Chase | |
|-----------------|--|
| Pixel INT: | <input type="text" value="50.0%"/> |
| Bkgd INT: | 50.0% |
| Pixel Size: | S <input checked="" type="radio"/> M <input type="radio"/> L ▼ |

| Two Color Chase | |
|-----------------|--|
| Pixel INT: | <input type="text" value="50.0%"/> |
| Bkgd INT: | 50.0% |
| Pixel Size: | S <input checked="" type="radio"/> M <input type="radio"/> L ▼ |

| Three Color Chase | |
|-------------------|--|
| Pixel INT: | <input type="text" value="50.0%"/> |
| Bkgd INT: | 50.0% |
| Pixel Size: | S <input checked="" type="radio"/> M <input type="radio"/> L ▼ |

| Rainbow | |
|------------|--|
| Pixel INT: | <input type="text" value="50.0%"/> |
| Speed: | 100cm/s |
| Move: | LT <input checked="" type="radio"/> RT ▼ |

| Pixel Fire | |
|------------|--|
| INT Range: | <input type="text" value="50.0%"/> - 75.0% |
| Bkgd INT: | 50.0% ▼ |

3.7 Custom FX

Press **MENU** to access the system menu, rotate and press the control wheel to select Custom FX. You can choose to enter Picker FX or Music FX. Each type can save 10 custom FXs. In the name of each FX, "NO FX" means unsaved FX, and "Untitled" means saved FX.

| Custom FX | |
|----------------------------------|-----------|
| <input checked="" type="radio"/> | Picker FX |
| <input type="radio"/> | Music FX |

3.8 Overheat Protection

Press **MENU** to access the system menu, rotate and press the control wheel to select Overheat Protection.

Black Out: Black Out the fixture when it overheats.

Reduce Intensity: Set to 70% of the maximum intensity when INFINIBAR is overheated.

| Overheat Protection | |
|-------------------------------------|------------------|
| <input checked="" type="checkbox"/> | Black Out |
| <input checked="" type="checkbox"/> | Reduce Intensity |

3.9 Runtime

Press MENU to access the system menu, rotate and press the control wheel to select Runtime. Maximum brightness will be adjusted based on current power to set **2 / 4 / 6 / 8 hours**, or select **Standard** maximum power output.

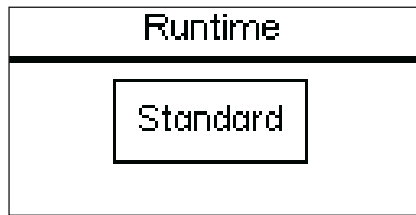

3.10 Freq. Selection

Press MENU to access the system menu, rotate and press the control wheel to select Freq. Selection. Rotate the control wheel to adjust the light frequency by 100Hz every turn.

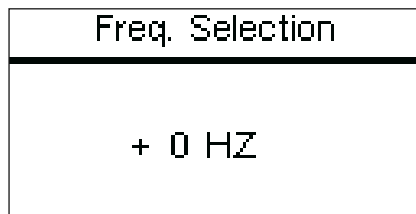

3.11 DMX Settings

Press **MENU** to access the system menu, rotate and press the control wheel to select DMX Setting.

DMX Address: Choose the DMX address of INFINIBAR, press and hold the control wheel for 2 seconds to lock/unlock the DMX address (Prevent accidental touch to exit DMX mode)

DMX Profiles: Rotate the control wheel and press to choose DMX profile.

DMX Loss Behavior:

- 1.Hold Last Setting: After DMX signal is lost, remember the last control setting
- 2.Black Out: when the DMX signal is lost, it will be Black out
- 3.Fade To Black: after DMX signal is lost, it will fade to Black in 60 seconds
- 4.Hold 2min & Fade Out: After the DMX signal is lost, keep the last control setting for two minutes, and then Fade to Black within 60 seconds

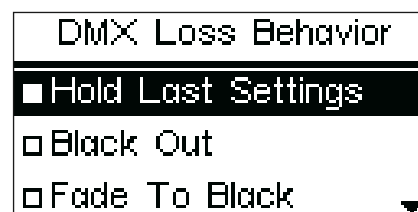
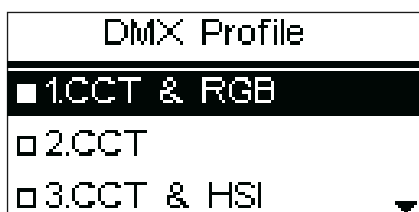
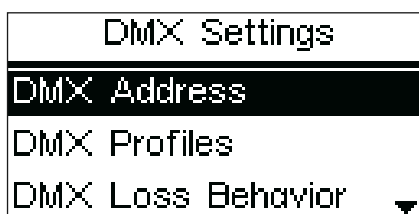

* The fade-out time decreases as the percentage of brightness decreases. When the brightness output is 100%, the fade-out time is 60 seconds, which decreases in sequence.

* If the signal is reconnected, the DMX console will continue to maintain the signal output as same as before

3.12 CRMX Settings

Press **MENU** to access the system menu, rotate and press the control wheel to select CRMX Setting mode.

CRMX Status: When CRMX Status is ON, it will continuously search for a pairable signal in the background to connect.

Unpair: Unpair will disconnects the currently established connection so that other signal transmitters can be paired.

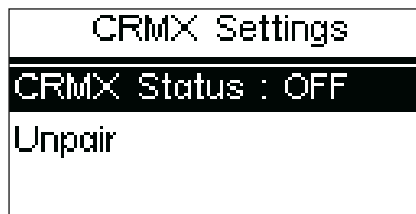

3.13 BT Setting

Press **MENU** to access the system menu, rotate and press the control wheel to select BT Setting mode.

BT Status: Rotate and press the control wheel to turn on/off Bluetooth.

BT Reset: Reset the INFINIBAR Bluetooth connection, and your mobile phone or tablet will be able to connect to and control the light with Sidus Link App.

BT UID: See the Bluetooth Unique Identifier.

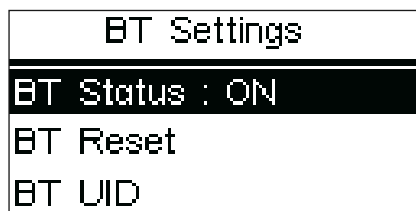

3.14 Studio Mode

Press **MENU** to access the system menu, rotate and press the control wheel to select Studio Mode.

Rotate and select "YES" or "NO" to turn on or turn off the Studio Mode.

When the studio mode is turned on, the power supply of the lamp can be turned on directly; when the studio mode is turned off, you need to turn on the toggle switch to running the lamp.



3.15 Update

Press **MENU** to access the system menu, rotate and press the control wheel to select Update.

Update Firmware: Select "Yes" to update via USB-C.

Firmware update also be done via Sidus Link app using OTA (Over the Air Technology).

Firmware Version: See the current fixture firmware version.



3.16 Language

Press **MENU** to access the system menu, rotate and press the control wheel to select Language, Rotate and press the control wheel to select **English** or **Simplified Chinese**.



3.17 Factory Reset

Press **MENU** to access the system menu, rotate and press the control wheel to select Factory Reset.

Factory Setting:

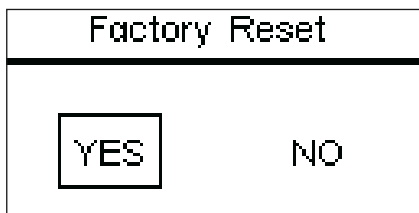

Light Mode: Intensity 50%, CCT 5600K, G/M 0;

Language: English;

BT Status: ON;

DMX: Address 001, Profile CCT&RGB, Hold Last Setting. **Overheat Protection:** Reduce Intensity

Runtime: Standard

3.18 Product Info

Press **MENU** to access the system menu, rotate and press the control wheel to select Product Info to see **Hardware Version**.



3.19 Screensaver

Press **MENU** to access the system menu, rotate and press the control wheel to select Screensaver mode. You can choose to turn the screensaver on after **30/60/120 minutes** or **turn it off**.

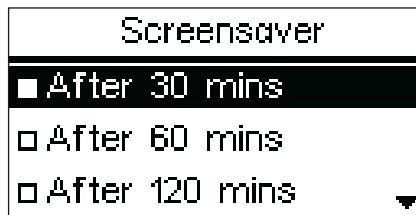

3.20 Exit

Press **MENU** to access the system menu, rotate and press the control wheel to select Exit. It will go back to the previous interface.

4. DMX Control

4.1 Connect a standard DMX controller

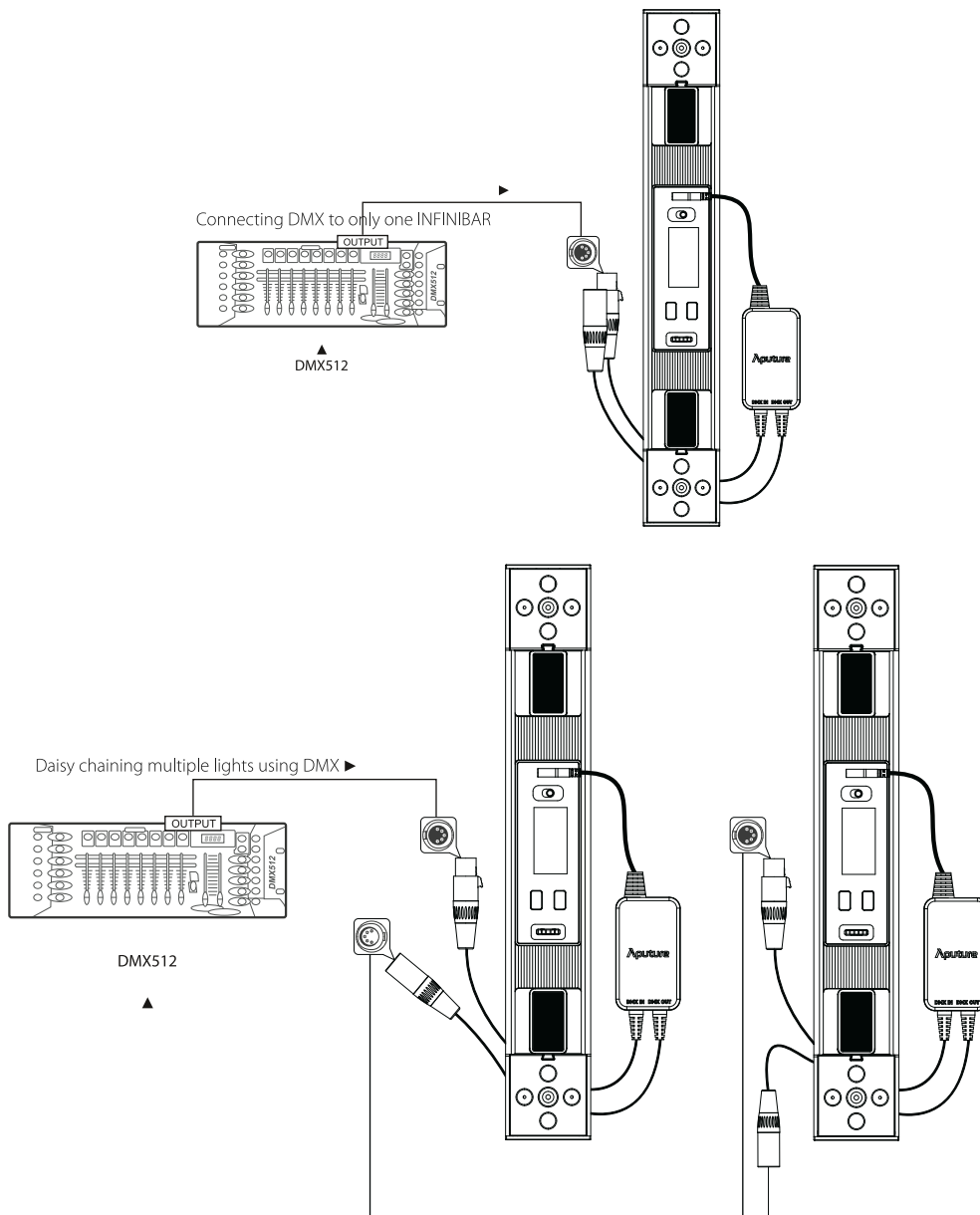

* USB-C to 5-Pin XLR In & Out adapter sold separately

4.2 DMX Interface

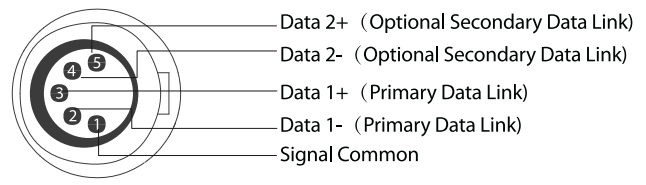
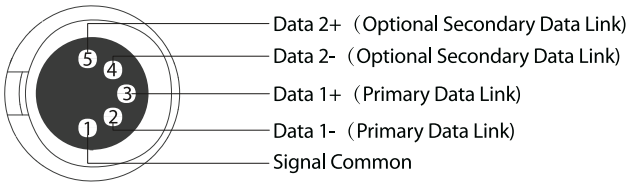

4.3 Channel selection

In DMX mode, match the channel of your DMX controller with the light, and then adjust accordingly.

* The default DMX channel is 001.

* The range of DMX channels is 1 to 512.

4.4 DMX Profile

The INFINIBAR offers a variety of DMX modes. Please find a detailed overview of all DMX modes in the document, DMX Chart is available for free download on the Aputure official website <https://www.aputure.com>.

5.Using the Sidus Link APP

You can download the Sidus Link app from the iOS App Store or Google Play Store for enhancing the functionality of the light. Please visit Sidus.link/app/help for more details regarding how to use the app to control your Aputure lights.



Get Sidus Link[®] App



Sidus.link/app/help

Specifications

| | | | |
|---|--|------------------------------|---|
| Adapter Input Power | PB3: 10W PB6: 20W PB12: 40W | Power Output | PB3: 6.5W PB6: 14W PB12: 27W |
| CCT Range | 2000 K - 10000 K | Battery | PB3: 7.4 V/2000 mAh PB6: 7.4 V/4000 mAh PB12: 7.4 V/8000 mAh |
| CRI | ≥ 96 | Battery Runtime | 100% Intensity: PB3: 120 mins PB6: 100 mins PB12: 80 mins |
| TLCI | ≥ 98 | Charging time | PB3: 115 mins PB6: 115 mins PB12: 210 mins |
| Control Methods | Sidus Link APP, DMX ,CRMX, On-board | Operating Temperature | -10 - +45 °C |
| Dimensions (L x W x H) | PB3: 304 x 45 x 52 mm / 12.0 x 1.7 x 2.0 in PB6: 604 x 45 x 43 mm / 23.8 x 1.7 x 1.7 in PB12: 1204 x 45 x 43 mm / 47.4 x 1.7 x 1.7 in | Weight | PB3: 598 g / 1.3 lbs PB6: 1000 g / 2.2 lbs PB12: 1955 g / 4.3 lbs |
| Flight case maximum charging power | 270 W | Flight case Size | 1436x595x216 mm / 57x23x9 in |
| Weight (Flight case) | 20 kg / 44 lbs | Weight (with lamps) | 55 kg / 121 lbs |

**This data is based on average brightness measurements, there will be slight variations between lights.*

Photometrics

INFINIEAR PB3

| CCT | 0.5 m | 1 m |
|------------|--------------|------------|
| 2,000 K | 448 lux | 85 lux |
| 2,700 K | 486 lux | 127 lux |
| 3,200 K | 512 lux | 130 lux |
| 4,300 K | 540 lux | 137 lux |
| 5,600 K | 545 lux | 144 lux |
| 6,500 K | 544 lux | 147 lux |
| 7,500 K | 544 lux | 145 lux |
| 10,000K | 497 lux | 135 lux |
| R | 111 lux | 40 lux |
| G | 353 lux | 98 lux |
| B | 56 lux | 20 lux |

INFINIEAR PB6

| CCT | 0.5 m | 1 m |
|------------|--------------|------------|
| 2,000 K | 635 lux | 200 lux |
| 2,700 K | 935 lux | 282 lux |
| 3,200 K | 940 lux | 288 lux |
| 4,300 K | 978 lux | 301 lux |
| 5,600 K | 1026 lux | 317 lux |
| 6,500 K | 1048 lux | 326 lux |
| 7,500 K | 1046 lux | 328 lux |
| 10,000K | 960 lux | 288 lux |
| R | 189 lux | 78 lux |
| G | 608 lux | 188 lux |
| B | 97 lux | 39 lux |

INFINIEAR PB12

| CCT | 0.5 m | 1 m |
|------------|--------------|------------|
| 2,000 K | 975 lux | 350 lux |
| 2,700 K | 1350 lux | 532 lux |
| 3,200 K | 1410 lux | 542 lux |
| 4,300 K | 1500 lux | 564 lux |
| 5,600 K | 1600 lux | 593 lux |
| 6,500 K | 1650 lux | 607 lux |
| 7,500 K | 1650 lux | 617 lux |
| 10,000K | 1510 lux | 563 lux |
| R | 227 lux | 85 lux |
| G | 793 lux | 297 lux |
| B | 131 lux | 49 lux |

Detailed Parameters of FX Control

System FX

| | | | | | |
|------------------------|----------------------|--|---|-----|-------------|
| Paparazzi II | INT | 0% - 100% | | | |
| | CCT | 2000 K - 10000 K | | | |
| | G/M | -1.0 - +1.0 | | | |
| | Intervals | [0.2S - 1.0S] - [2.0S - 18.0S] | | | |
| | Status | Stop / Loop | | | |
| LightningIII | INT | 0% - 100% | | | |
| | Mode | CCT | 2000 K - 10000 K | G/M | -1.0 - +1.0 |
| | | HSI | 1 - 360° | SAT | 0 - 100 % |
| | | CCT | 2000 K - 10000 K | | |
| | Intervals | [1.5S - 3.0S] - [2.6S - 30.0S] | | | |
| Status | Stop / Trigger /Loop | | | | |
| TV III | INT | 0% - 100% | | | |
| | Mode | CCT | [2000 K - 9900 K] - Range [2100 K - 10000 K] | G/M | -1.0 - +1.0 |
| | | HSI | [0° - 359°] - [1° - 360 °] | SAT | 0 - 100 % |
| | | Range | CCT 2000 K - 10000 K | | |
| | Intervals | [0.5S - 2S] - [5.0S - 15.0S] | | | |
| Status | Stop / Loop | | | | |
| Fire III | INT | 0% - 100% | | | |
| | Mode | CCT | [1400 K - 9900 K] - Range [1800 K - 10000 K] | G/M | -1.0 - +1.0 |
| | | HSI | [0° - 359°] - [1° - 360 °] | SAT | 0 - 100 % |
| | | Range | CCT 2000 K - 10000 K | | |
| | FRQ | 60 - 240 /min | | | |
| Status | Stop / Loop | | | | |
| Faulty Bulb III | INT | 0% - 100% | | | |
| | Mode | CCT | 2000 K - 10000 K | G/M | -1.0 - +1.0 |
| | | HSI | 1 - 360° | SAT | 0 - 100 % |
| | | CCT | 2000 K - 10000 K | | |
| | Intervals | [0.3S - 1.8S] - [1.8S - 7.5S] | | | |
| Status | Stop / Loop | | | | |
| Pulsing III | INT | 0% - 100% | | | |
| | Mode | CCT | 2000 K - 10000 K | G/M | -1.0 - +1.0 |
| | | HSI | 1 - 360° | SAT | 0 - 100 % |
| | | CCT | 2000 K - 10000 K | | |
| | Pluses | 10 - 200 /min | | | |
| Status | Stop / Loop | | | | |
| Cop Car III | INT | 0% - 100% | | | |
| | Colors | R / B / R+B / B+W /R+B+W | | | |
| | FRQ | Single / Double / Quad / Quint / Quint all / Cycle | | | |
| | Status | Stop / Loop | | | |

| | | |
|-----------------------|--------|-------------|
| Party Light II | INT | 0% - 100% |
| | SAT | 0 - 100% |
| | Speed | 1 - 60S |
| | Status | Stop / Loop |

| | | |
|--------------------|-----------|----------------------------------|
| Firework II | INT | 0% - 100% |
| | Mode | CCT / HUE / CCT+HUE |
| | Intervals | [0.5S - 9S] - [2.0S - 11.0S] |
| | Status | Stop / Loop |

Pixel FX

| | | |
|-------------------|---------------------|---|
| Color Fade | INT | 0% - 100% |
| | Color No | 1 / 2 / 3 / 4 |
| | Color 1 | Black / |
| | Color 2 | HUE: 30° / 60° / 90° / 120° / 150° / 180° / 210° / 240° / 270° / 300° / 300° / 360° |
| | Color 3 | / |
| | Color 4 | CCT: 2500K 3200K / 4300K / 5600K / 6500K / 7500K |
| | Speed | 1 - 640 cm/s |
| | Move | Left / Right |
| Status | Play / Pause / Stop | |

| | | |
|--------------------|---------------------|--|
| Color Cycle | INT | 0% - 100% |
| | Color No | 1 / 2 / 3 / 4 |
| | Color 1 | Black / |
| | Color 2 | HUE: 30° / 60° / 90° / 120° / 150° / 180° / 210° / 240° / 270° / 300° / 300° / |
| | Color 3 | 360° / |
| | Color 4 | CCT: 2500K 3200K / 4300K / 5600K / 6500K / 7500K |
| | Transfer | Step / Smooth |
| | Speed | 0.1 - 10.0S |
| Move | Left / Right | |
| Status | Play / Pause / Stop | |

| | | |
|------------------------|--|--|
| One Pixel Chase | Pixel INT | 0% - 100% |
| | Bkgd INT | 0% - 100% |
| | Pixel Size | S / M / L |
| | Departure | 1 Way / 2 Way |
| | Color 1 | Black (Blackground Only) / |
| | Color 2 | HUE: 30° / 60° / 90° / 120° / 150° / 180° / 210° / 240° / 270° / 300° / 300° / |
| | Blackground | 360° / |
| | | CCT: 2500K 3200K / 4300K / 5600K / 6500K / 7500K |
| | Speed | 1 - 640 cm/s |
| Move | Left / Right / Loop (1 Way) Bounce / Cross (2 Way) | |
| Status | Play / Pause / Stop | |

| | | |
|------------------------|--|---|
| Two Pixel Chase | Pixel INT | 0% - 100% |
| | Bkgd INT | 0% - 100% |
| | Pixel Size | S / M / L |
| | Departure | 1 Way / 2 Way |
| | Color 1 | Black (Blackground Only) / |
| | Color 2 | HUE: 30° / 60° / 90° / 120° / 150° / 180° / 210° / 240° / 270° / 300° / 300° / 360° |
| | Color 3 | / |
| | Color 4 | CCT: 2500K 3200K / 4300K / 5600K / 6500K / 7500K |
| | Blackground | |
| Speed | 1 - 640 cm/s | |
| Move | Left / Right / Loop (1 Way) Bounce / Cross (2 Way) | |
| Status | Play / Pause / Stop | |

| | | |
|--------------------------|--|---|
| Three Pixel Chase | Pixel INT | 0% - 100% |
| | Bkgd INT | 0% - 100% |
| | Pixel Size | S / M / L |
| | Departure | 1 Way / 2 Way |
| | Color 1 | Black (Blackground Only) / |
| | Color 2 | HUE: 30° / 60° / 90° / 120° / 150° / 180° / 210° / 240° / 270° / 300° / 300° / 360° |
| | Color 3 | / |
| | Color 4 | CCT: 2500K 3200K / 4300K / 5600K / 6500K / 7500K |
| | Color 5 | |
| Color 6 | | |
| Blackground | | |
| Speed | 1 - 640 cm/s | |
| Move | Left / Right / Loop (1 Way) Bounce / Cross (2 Way) | |
| Status | Play / Pause / Stop | |

| | | |
|----------------|--------|---------------------|
| Rainbow | INT | 0% - 100% |
| | Speed | 1 - 640 cm/s |
| | Move | Left / Right |
| | Status | Play / Pause / Stop |

| | | |
|-------------------|-----------------------|---|
| Pixel Fire | INT Range | [0% - 75%] - [25% - 100%] |
| | Bkgd INT | 0% - 100% |
| | Fire 1 | Black / |
| | Blackground | HUE: 30° / 60° / 90° / 120° / 150° / 180° / 210° / 240° / 270° / 300° / 300° / 360° |
| | | / |
| | | CCT: 2500K 3200K / 4300K / 5600K / 6500K / 7500K |
| Frequency | 1 - 10 Hz | |
| Move | Horizontal / Vertical | |
| Status | Play / Pause / Stop | |